

ALBAN GIACOMO SPA

Via A. De Gasperi, 75
36060 Romano d'Ezzelino (VI) Italy
+39 0424 832832
www.agb.it
info@agb.it

Z903910189 -04.23

Index

4	Wave
6	Tocuh & Close
8	Raso 90
11	Kit Scivola
12	Genio
14	Sentinel
18	Artech plana
20	Imago ++
22	Lift&Slide - Autobrake
23	Lift&Slide XC

WAVE

The minimal handle combining grip and closure



Secure and comfortable grip



Minimal design: linear, coplanar, essential



Unique milling for all closing versions

Wave is the first handle that creates a continuity of shape both for swinging and sliding doors, always very different one from the other: Wave allows the transversality of the handle on all the doors of the house!



Wave fits in swinging and sliding doors maintaining the same shape

Wave solution for swinging doors

Polaris Wave

- Lock with magnetic latch.
- Bathroom and cylinder versions.
- Finishes: black, white and matt chromium plated.

Wave

- Passage, privacy and cylinder.
- Finishes: black, white and matt chromium plated.

Wave solution for sliding doors

Scivola Tre Class

- Lock with hook and concealed pull out lever.
- Bathroom and cylinder versions.
- Finishes: black, white and matt chromium plated.

Wave

- Passage, privacy and cylinder.
- Finishes: black, white and matt chromium plated.

TOUCH & CLOSE

All the privacy you need

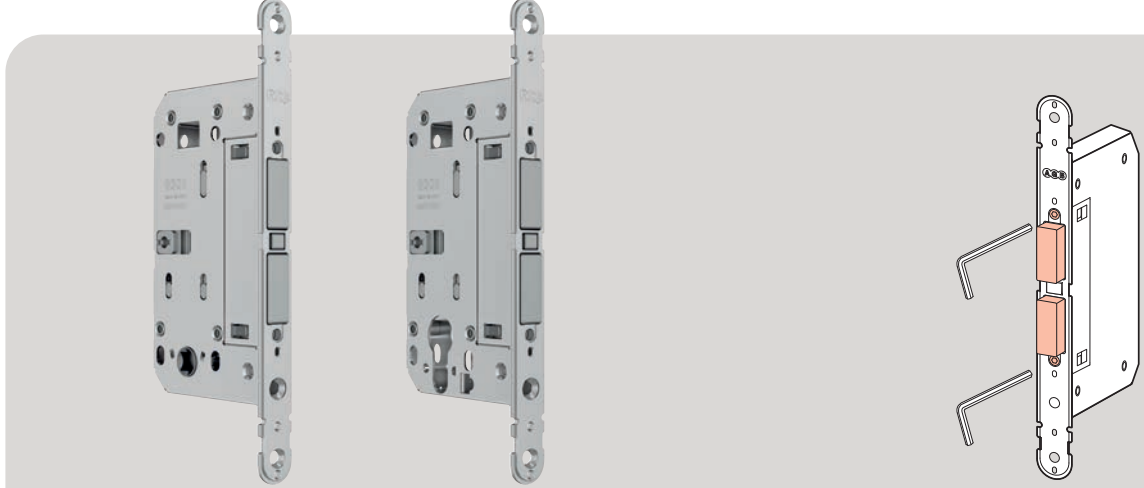
Touch & Close

- Lock with adjustable magnetic door catcher.
- Bathroom and cylinder versions.
- Finishes: grey RAL 7036, matt black and matt white.

Rotating the grubs increases the working stroke of the magnetic latches and therefore the force of attraction between the sash part and the frame.



Cover

- The cover hides the fixing screws of Touch & Close.

Finishes

- Matt chromium plated
- Matt black
- Matt white

Accessories

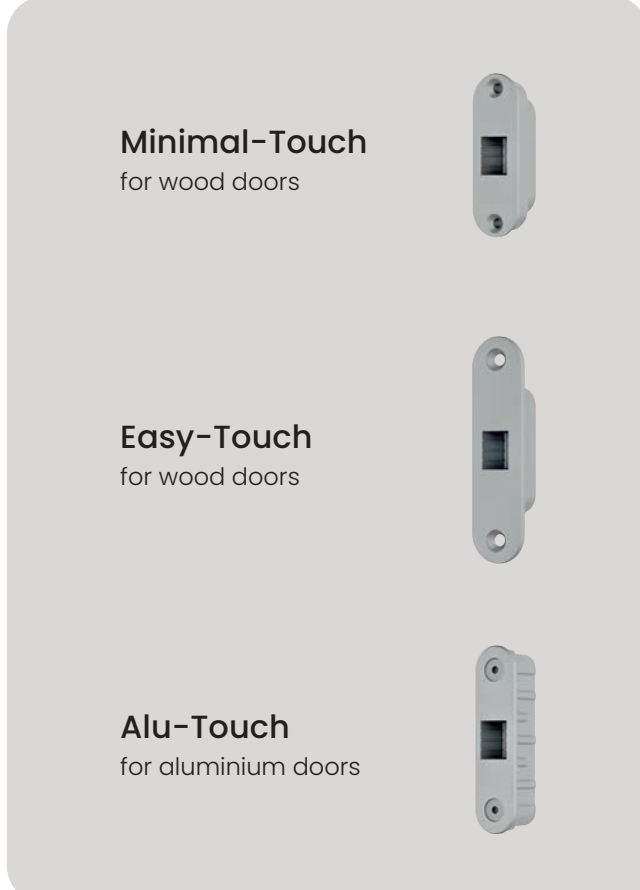

Minimal-Touch
for wood doors

Easy-Touch
for wood doors

Alu-Touch
for aluminium doors



With bolt

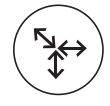

Adjustable



Unleash the designer's creativity

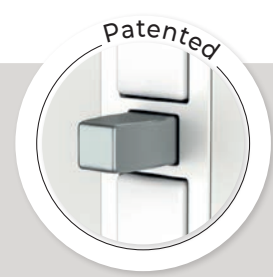

Magnetic door catcher with lock

The conical shape of the bolt and of the striker tray guarantees the best closure in all conditions!

RASO 90

Aluminium profile for in-line doors with 90° junction

Extremely minimal aluminium profile with solid coupling thanks to the 90° joint bracket and all related accessories. All components are AGB patented. This solution allows to obtain flush doors perfectly fitting on plasterboard and masonry, blending with the surrounding walls and giving very versatile configurations that meet all needs.



Always a squared frame with 90° angle



Quick and easy installation



Solid coupling between transom and jambs

Raso 90 allows a precise and fast coupling between jambs and transom.

Finishes

- Anodised silver
- Matt white

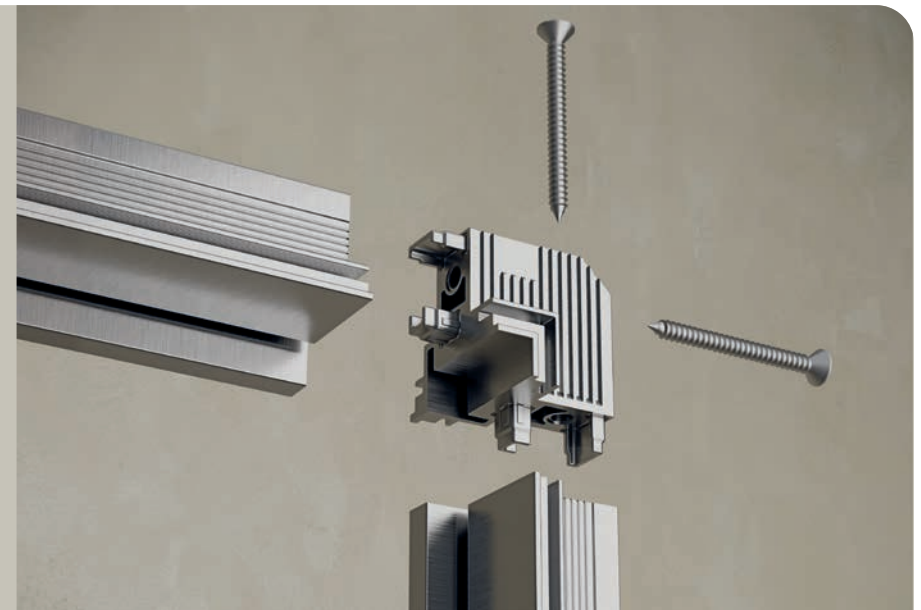
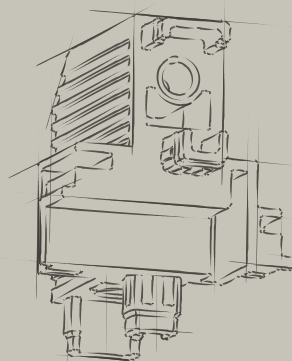

Installation on drywall

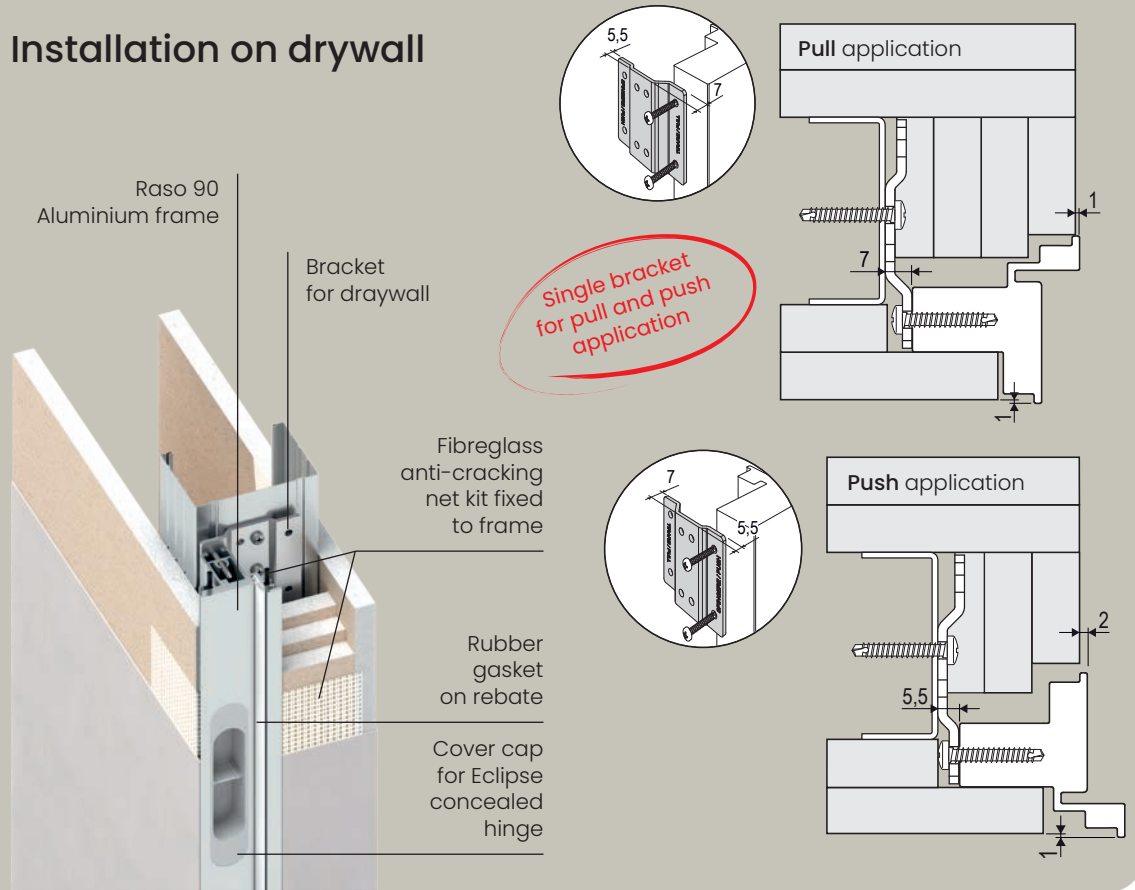

Installation on masonry

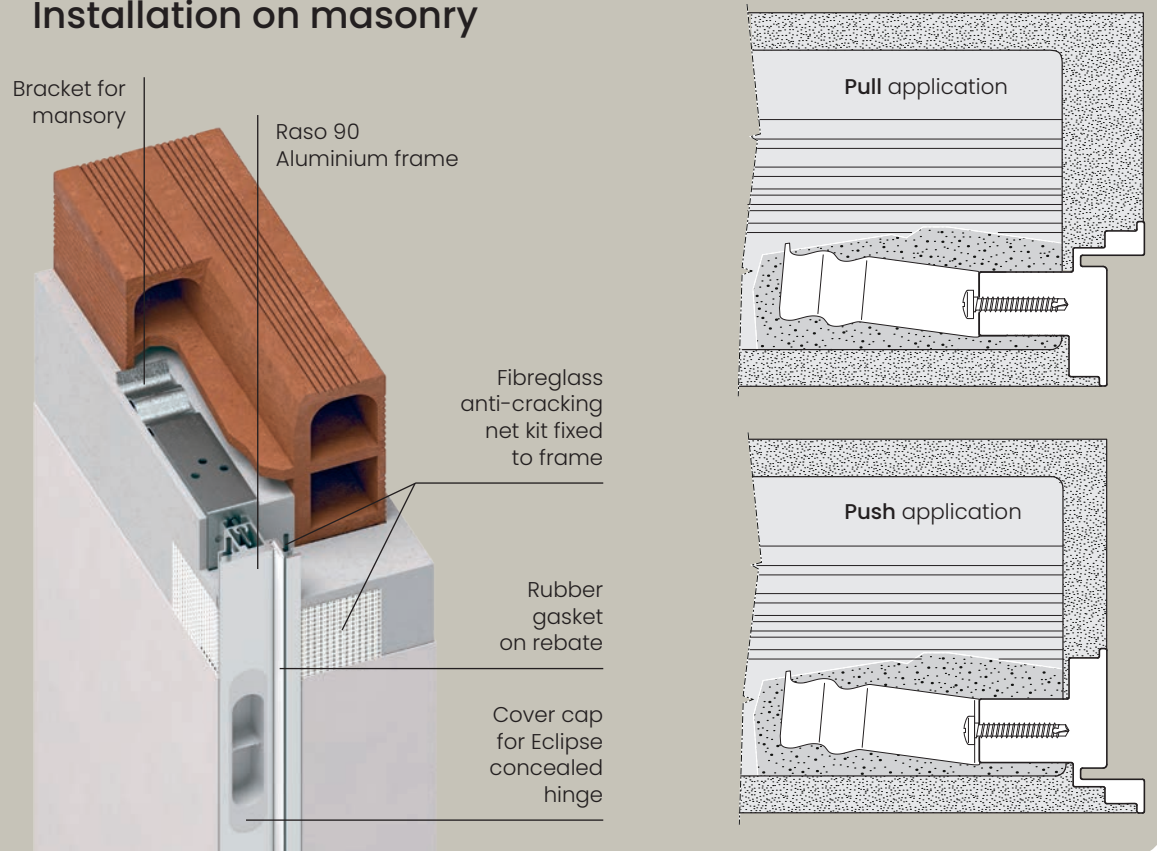

KIT SCIVOLA

New minimal design of the rosette



Concealed screws



Minimal protrusion down to 1,2 mm



Compatible with 35÷50 mm panels



Kit Q
 Round rosette knob-button
 Satin chromium



Kit Q
 Squared rosette knob-button
 Matt black

The new steel knobs are designed to maximize comfort and functionality, meeting the needs of the market.

Thickness reduction down to 1.2 mm allows the new rosettes to blend perfectly with sliding doors.

In the Scivola Tre Class lock kits a retractable lever has been added so to combine a comfortable handling with a smooth door sliding.

Also available in the following versions:

- Kit E** - passage rosette
- Kit G** - key hole rosette
- Kit K** - cylinder hole rosette

Genio

High security cylinder with controlled key duplication



New finish: Nickel matt

Genio is a European profiled cylinder with patented and certified key achieving the highest degree of safety according to EN 1303:2015.

The owner's key is exclusively duplicated by the AGB Genio Point authorized center: a guarantee of reliability and protection for the customer.



Picking and bumping resistance



Drilling resistance



Snapping and pulling resistance



High number of combinations

European profile cylinder EN 1303:2015



Key security	1	2	3	4	5	6
Durability	1	2	3	4	5	6
Attack resistance	0	A	B	C	D	

Anti-picking: Pass
Anti-bumping: Level 3



Flat reversible key in brass.



Patented key.



Available in different profiles for territorial exclusivity.



Duplicable via security card.



Pass key as standard.



Reset key version available.



Ergonomic grip.



Security card

It has to be shown together with the key to obtain a duplicate.



A versatile cylinder

Suitable to any thickness of the door sash; wide choice of finishing and versions:

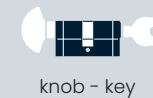
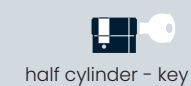
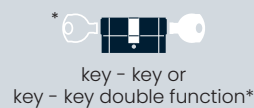

Sustainable and Made in Italy

Genio is fully manufactured in Italy: from the design, to materials and production. AGB chooses a sustainable packaging, made of 100% recyclable paper.

SENTINEL

OPEN EASILY, CLOSE SAFELY, LIVE COMFORTABLY

MOTORIZED AUTOMATIC MULTIPPOINT LOCK

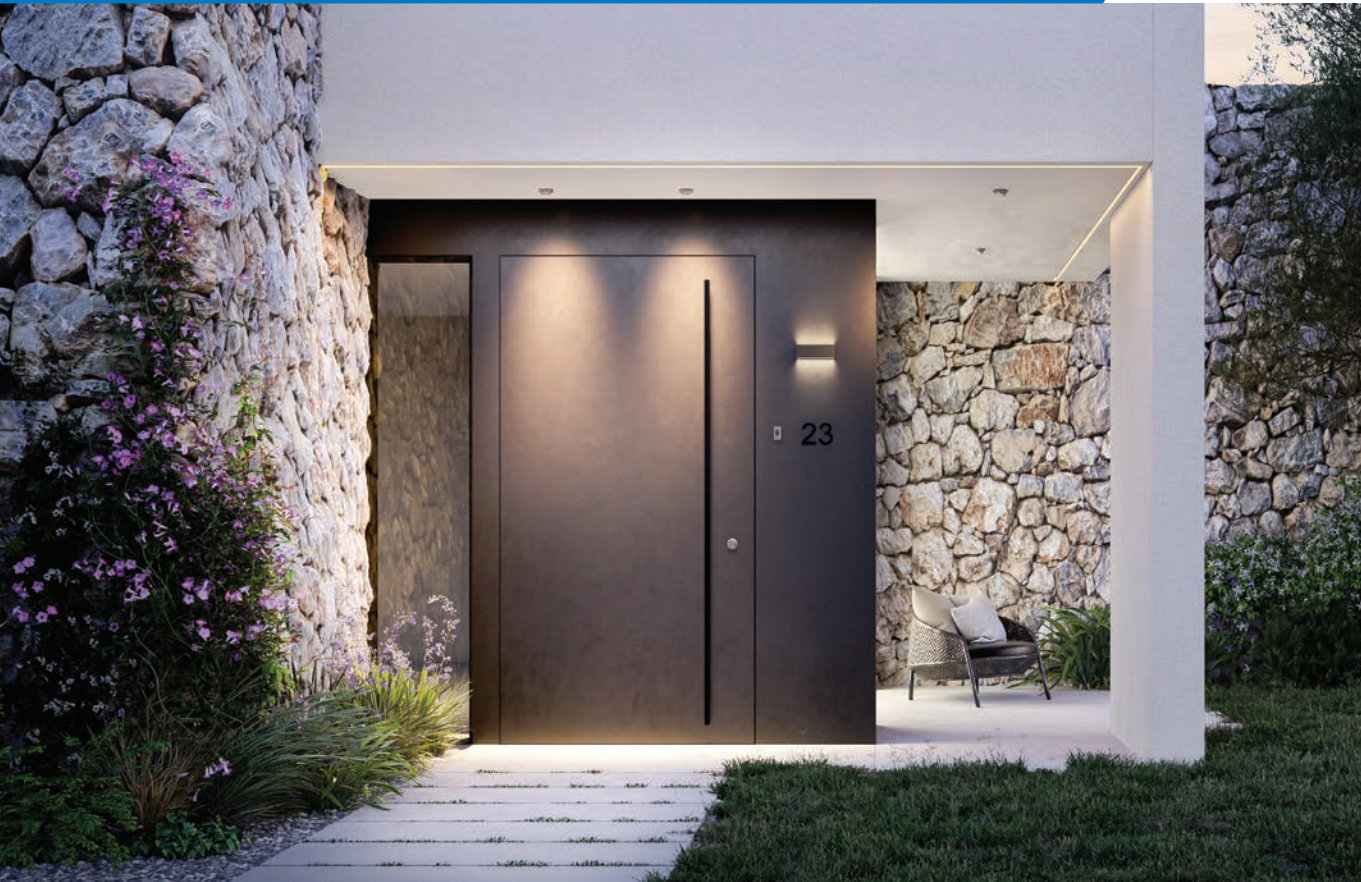

ANTIBURGLAR SECURITY

The hook offers a burglar-proof guarantee with special resistance to tearing.



COMFORT AND RELIABILITY

The lock is smooth and reliable in a wide variety of conditions.



THERMAL AND ACOUSTIC INSULATION

The closure points are positioned to keep the seals under pressure.

1 Three polymer-coated latches ensure maximum fluidity in sash opening and closing.

2 Two strong hooks made of hardened steel ensure the best protection from break-in attempts.

3 A magnet system allows to release the hook as soon as the sash shuts on the frame.

4 The optional motorization allows you to open the door from your smartphone with the access control app.

The AGB access control system can communicate directly with the Sentinel lock motor.

SENTINEL > SECURITY

1 Latch and hook are very close to each other: the alignment of the door panel and frame and the compression of the seals are achieved by the latch allowing free release of the hook. The hook release is independent from the latch to ensure burglar-proof locking in any condition.

2 The anti-cut steel hooks come out in a downward movement and remain locked at the end of the travel. This feature allows the hook to always release even if the spring, over time, may lose strength. Thanks to its geometry, the hook works perfectly with minimum and maximum gap and even if the sash sags.

3 The hook release mechanism is located close to the hooks and therefore:

- 1) More precise: it has no play due to component matching tolerances.
- 2) Faster: the proximity makes their release prompt and precise.



SENTINEL > TECHNOLOGY

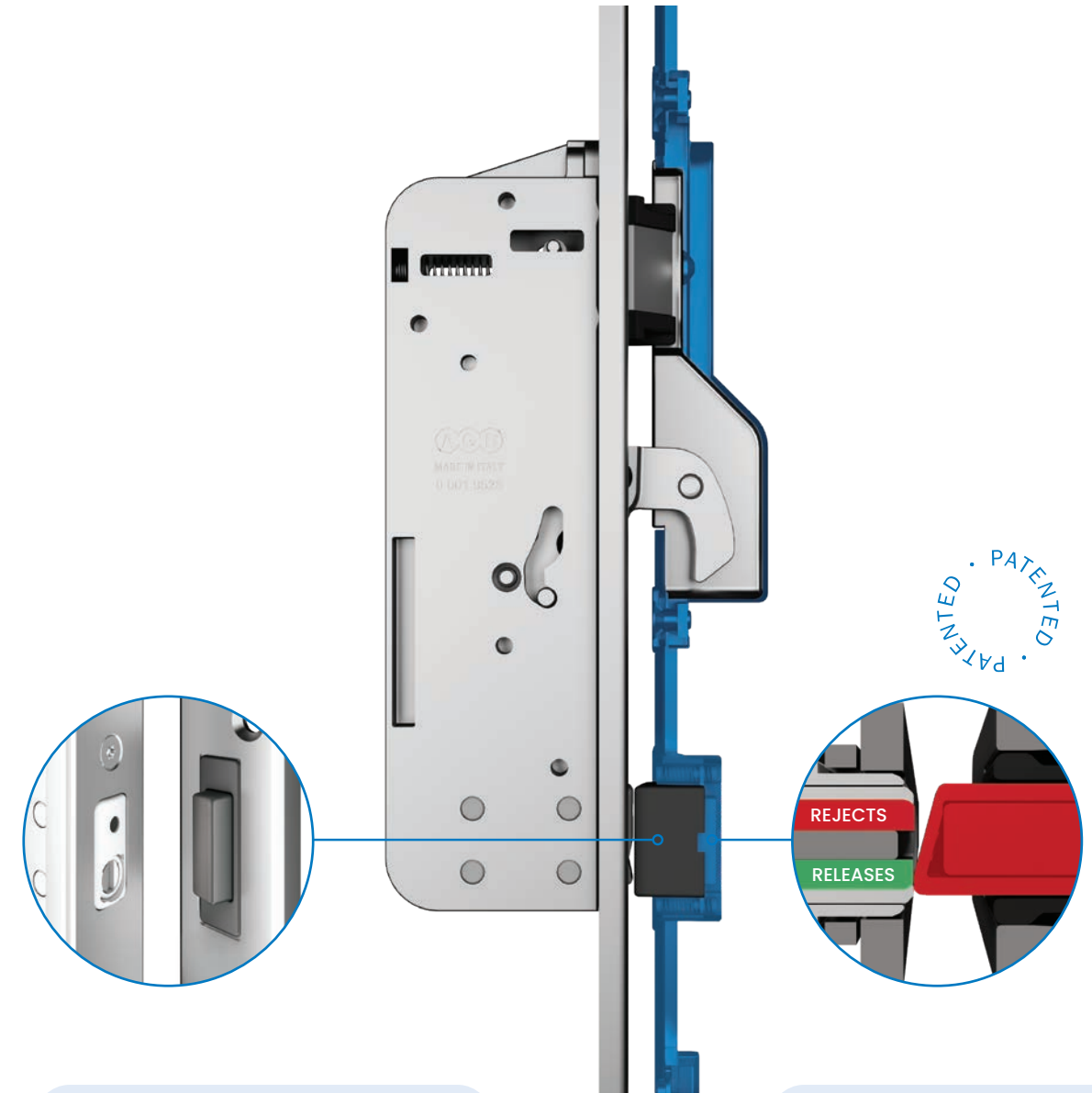

The release of the hooks is achieved when the **translating magnet** of the striker compensates the gap and goes in contact with the release device of the lock. The mechanism works through contact and not through magnetic field which may lose strength adjusting the hinges (max gap 16 mm).

The hooks are released by means of an **oriented polarity** system. This technology prevents early, unintentional or inappropriate hook releases and prevents damage to the frame.

ARTech plana

Concealed clampable hinge for aluminium system

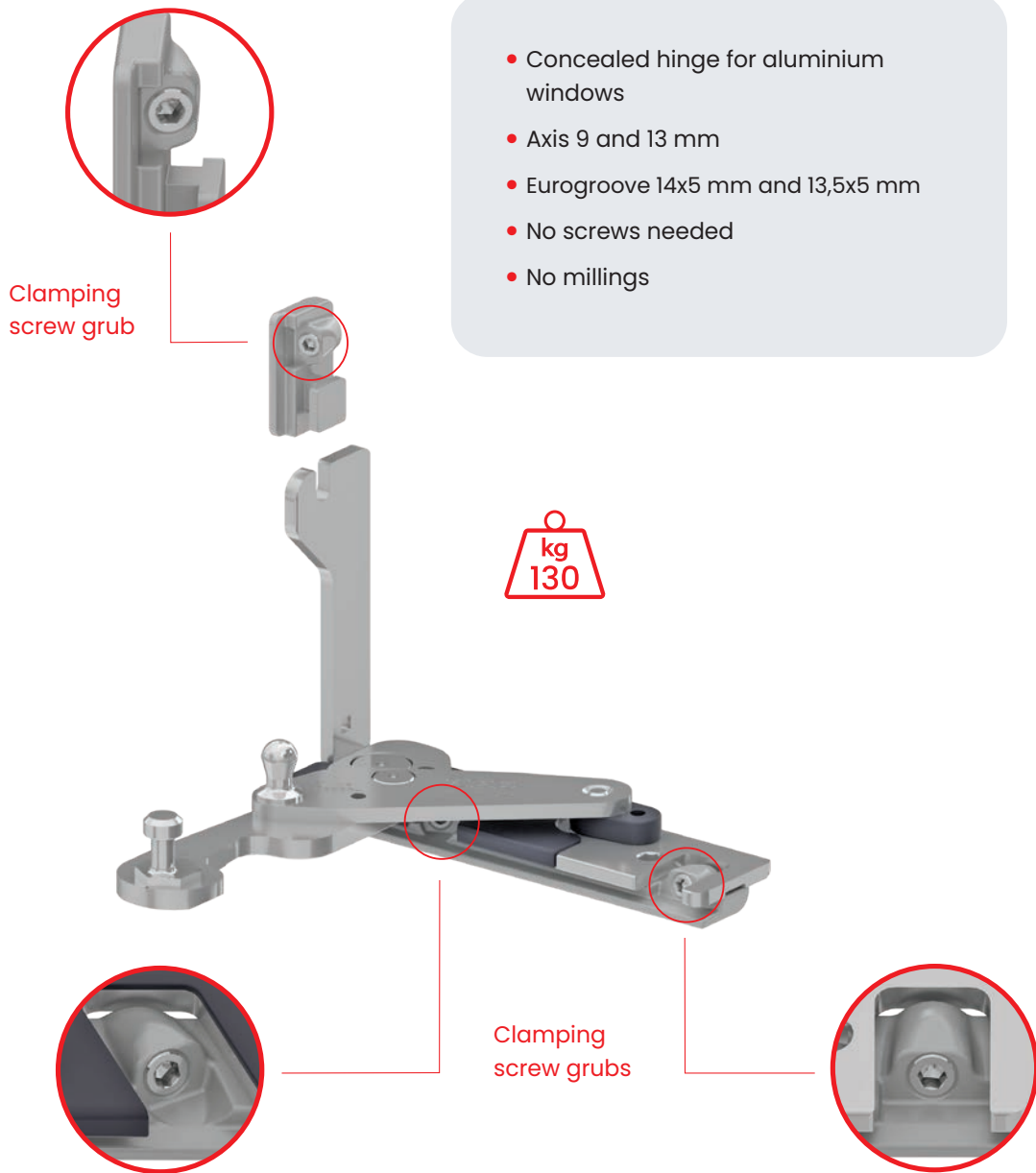
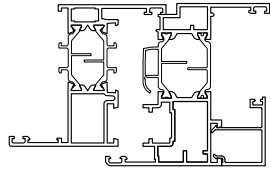

- Concealed hinge for aluminium windows
- Axis 9 and 13 mm
- Eurogroove 14x5 mm and 13,5x5 mm
- No screws needed
- No millings

Corner Drive

- Double cam for Tilt & Turn
- Suitable for aluminium systems with 16 mm hardware groove



Striker

- One striker fits all if used with double cam corner drive
- Axis 9 and 13 mm
- Eurogroove 14x5 mm and 13,5x5 mm
- Screw cover

IMAGO⁺⁺

+ DESIGN + SOLUTIONS



50 mm minimal profile.
on the side of the central node, does not interfere with the overlapping of the sashes and allows the jamb to be embedded into the frame.

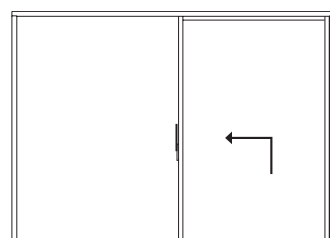

-  Minimal design
-  10% frame 90% glass
-  250 - 400 kg

IMAGO⁺⁺ LIFT & SLIDE LAYOUTS

3 SIDES FOR
FRAME CLOSING

2 SIDES FOR
SECOND SASHES

- 1 Rear Lock
- 2 Front Lock
- 3 Handle
- 4 Rear carriage (2 sides)
- 5 Front carriage (2 sides)
- 6 Front carriage (3 sides)
- 7 Supplementary carriages

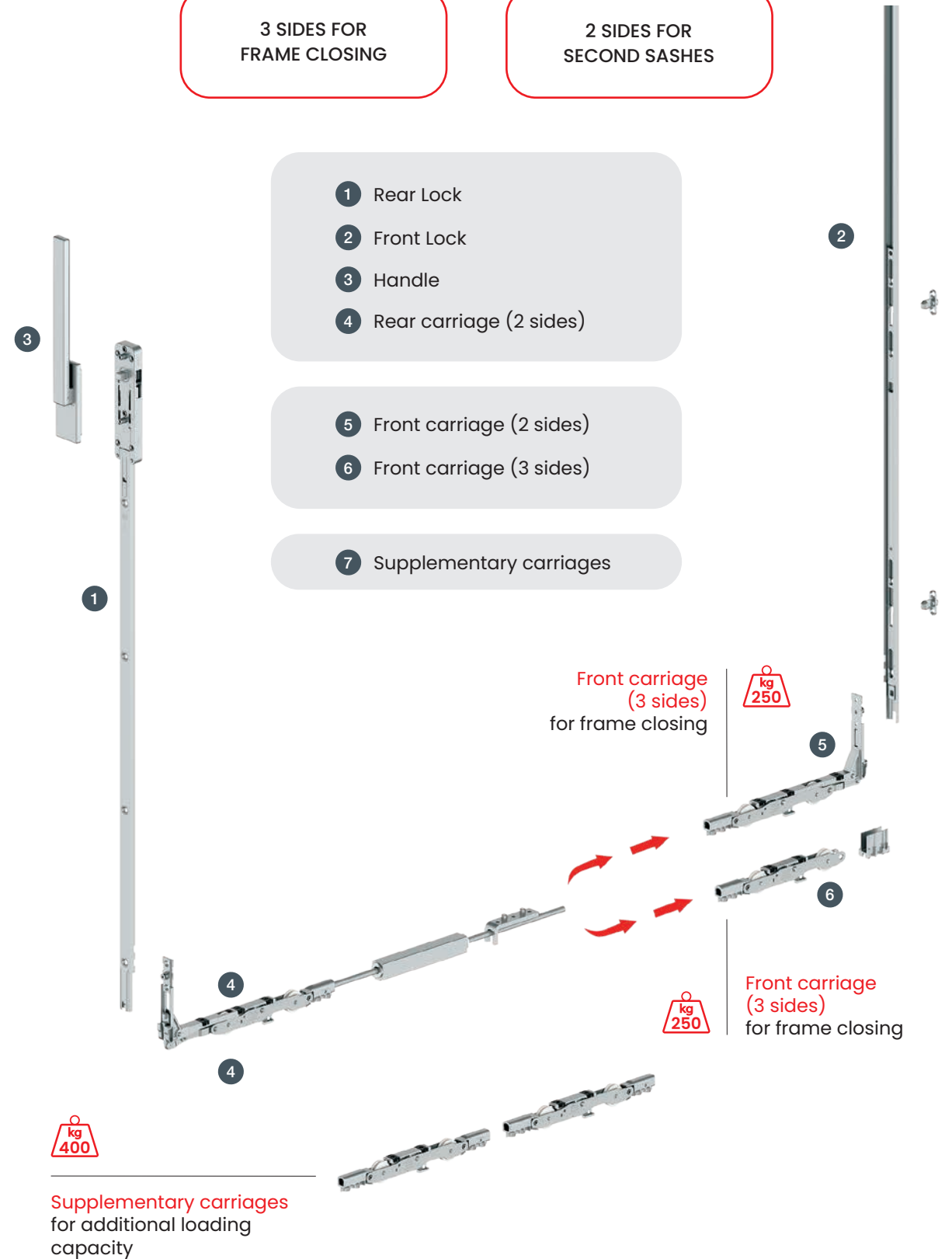

LIFT & SLIDE



pvc



aluminium

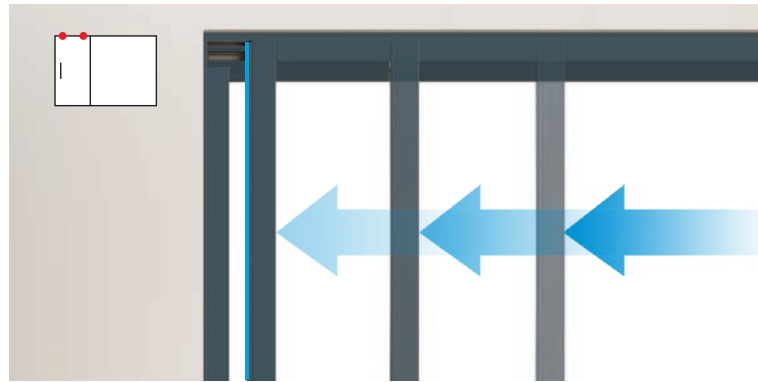

Auto brake system

Auto Brake system slows down and stops the sash before it reaches the frame. It can be used in opening and closing on the same sash at the same time. During the opening operation, Auto Brake is quite imperceptible, ensuring the maximum comfort.

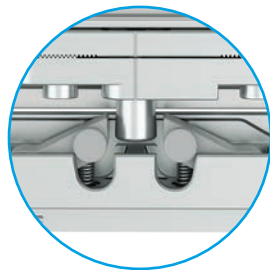

Auto brake system latch and release levers

Auto Brake for frame

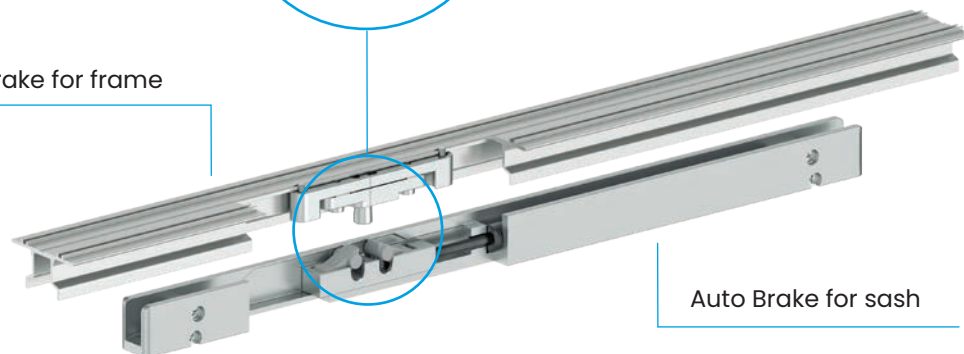

Auto Brake for sash

LIFT & SLIDE XC



aluminium

Movable pins lock

New movable pins lock in the XC Lift&Slide range allows adjustment of the single locking point by acting directly on the lock pin. Patented mechanism, unique in the market, designed to facilitate installation and maintenance of the door.

PATENTED



NEW!

Locking the adjustment on the movable pin with 4 mm Allen wrench

Adjustment of the movable pin in the horizontal axis with Allen wrench 3 mm

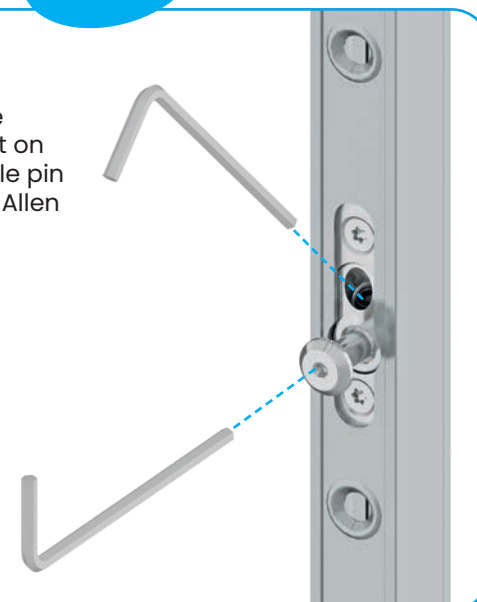

RC2

SKG

SKG





Open, Close, Live

Alban Giacomo SpA
Via A. De Gasperi, 75
36060 Romano d'Ezzelino (VI) Italy
+39 0424 832 832
www.agb.it - info@agb.it

MADE IN ITALY